

Article number: 2310431148

Description: E+G Levelling elements
LX.40-SW17-SST-M12X52

Measures

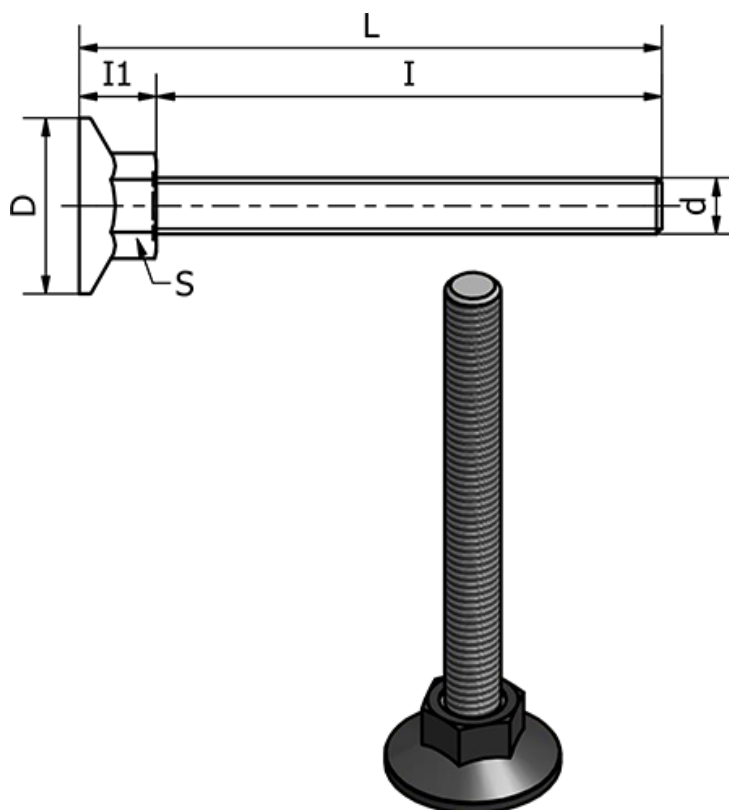

d = M12

D = 40

I = 52

I1 = 13

L = 49.5

S = 17

Static load in (N) = 5000

Type = AISI 304 Rustfast

Weight (g) = -